



ZERO SERIES

High-Output Coaxial Speakers

Owner's Manual



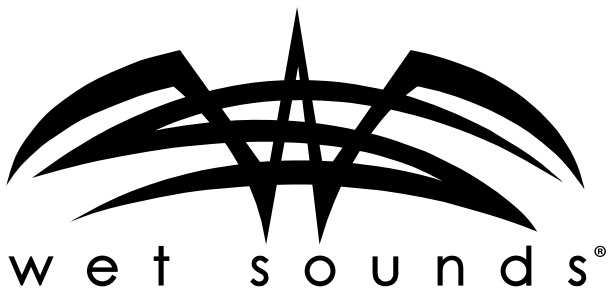

Congratulations!

Thank you for choosing this Wet Sounds™ product!

Wet Sounds is synonymous with live, loud, and clear audio solutions, built to serve the needs of the marine and powersports enthusiast. The ZERO Series is a first of its kind innovation for Wet Sounds, taking the legendary REV tower speaker performance and re-imagining it for optimal use in more confined spaces.

The high output in small, sealed enclosures means ZERO Series allows for ZERO compromises. These speakers can also be used with or without a twist-lock grille, making them ideal for both custom and OEM replacement applications. The ZERO Series speakers and subwoofers utilize materials such as Nylas, a composite of nylon and fiberglass, providing improved stability and superior strength versus conventional speaker materials.

Please take a moment to read the instruction manual before starting your installation. The guide will explain the benefits of the technologies developed by Wet Sounds and will help you understand the correct installation methods and use of this product. If you have any questions or concerns, please contact a certified Wet Sounds dealer. You may also contact Wet Sounds technical support by dialing 1-877-WET-SPKR (1-877-938-7757).

Table of Contents

Please take a moment to look over this instruction manual before enjoying the product.

Technology Specifications	3
Installation Specifications	4-5
Limited Warranty	6

Technology Specifications

ZERO 6 SPEAKER SPECIFICATIONS

RMS: 100W
Peak: 200W
Impedance: 4Ω
Frequency Response: 65Hz - 20kHz
Sensitivity: 90 dB at 1W/m
Mounting Depth: 2.72"
Hole Cut Out: 5.63"
Weight: 2.4 lbs (1.0 kg)

ZERO 8 SPEAKER SPECIFICATIONS

RMS: 150W
Peak: 300W
Impedance: 4Ω
Frequency Response: 55Hz to 20kHz
Sensitivity: 91.5 dB at 1W/m
Mounting Depth: 3.32"
Hole Cut Out: 7.36"
Weight: 3.4 lbs (1.5 kg)

Grille Options

XZ Grille

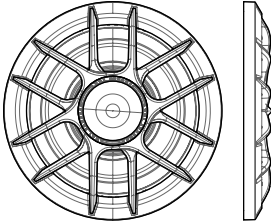

XY Grille

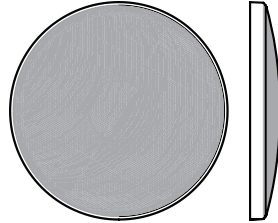

Grille Dimensions

ZERO 6: 6.89" x .91"

ZERO 8: 8.96" x 1.11"

ZERO 6: 6.97" x .96"

ZERO 8: 8.94" x 1.24"

Speaker Dimensions

ZERO 6

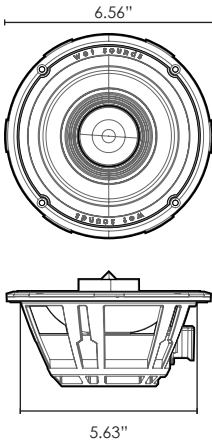

ZERO 8

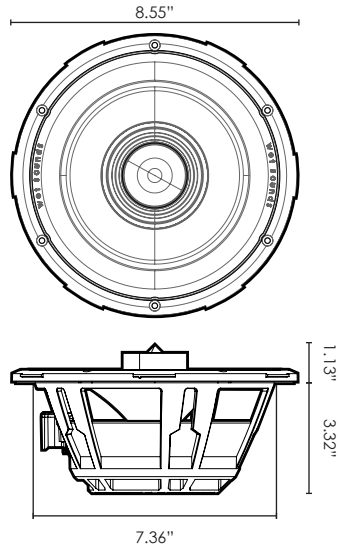

Installation Specifications

- 1 We recommend checking if the mounting surface is flat with a square or level. Mounting to a curved surface will damage the product.

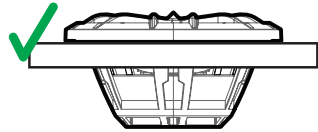
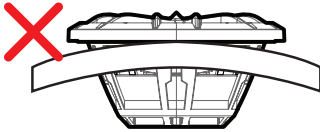

- 2 Tape the surrounding surface to prevent damaging the finish, and avoid cutting outside the cut line to prevent improper fitment.

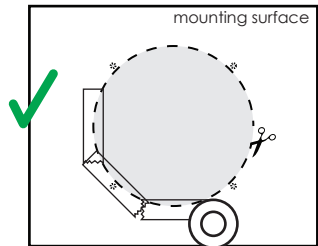
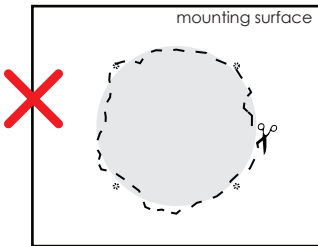

- 3 For speaker alignment, the terminal indicates the bottom of the speaker, and the opposing lock tabs help for horizontal alignment.

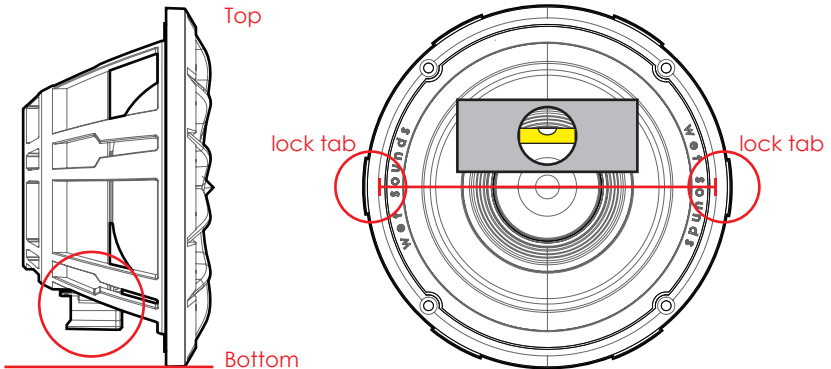

Continued on the next page.

Installation Specifications

- 4 Pre-drill the screw locations to prevent surface cracking.

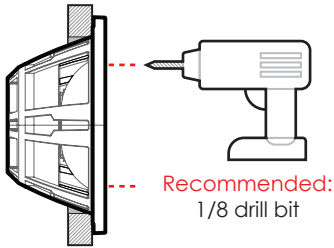

- 5 Fasten the speaker with stainless steel 5/32" x 1.25" Phillips screws.

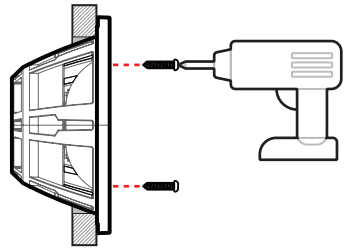

- 6 Place the grille on the speaker in a 45° angle.

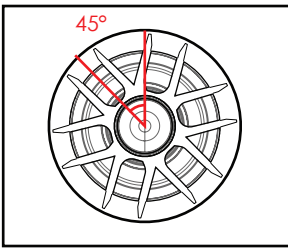

- 7 Apply downward pressure on the grille and twist clockwise to lock.

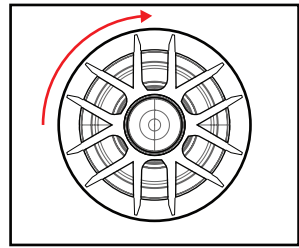

- 8 Connect the speakers to the amplifier or source unit using spade connectors for each terminal.

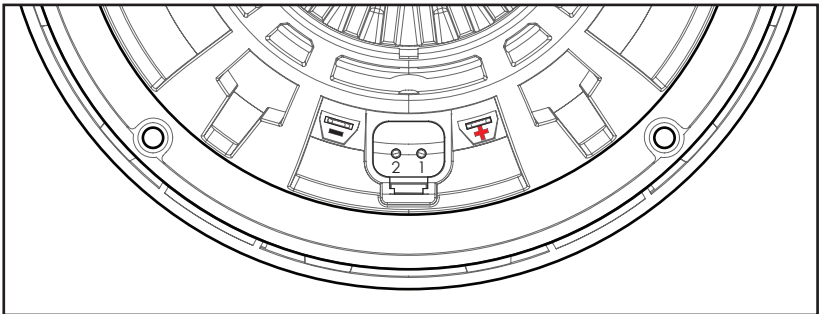

Note: ZERO Series has a standard Deutsch connector compatible connection. (PN: DT04-2P) PIN 1 (+) PIN 2 (-)

Limited Warranty

What This Warranty Covers

This is a "Limited" warranty. This warranty covers any defects in materials and workmanship and the warranty only applies to the original purchaser and is not transferable. This warranty is only valid if the original purchase was made from an authorized Wet Sounds dealer.

How Long Coverage Lasts

This warranty runs for 2 years from the date of the purchase.

What Is Not Covered

This warranty does not cover fading or discoloration caused by exposure to sunlight or chemicals such as ammonia, household bleach, or any cleaning material that contains abrasive substances. For information on how to prevent fading or discoloration, consult recommendations on cleaning products. Wet Sounds, Inc. does not cover the cost for removal and reinstallation of any kind. Additionally, shipping to Wet Sounds, Inc. is covered by the purchaser. This warranty is void and inapplicable if Wet Sounds deems that the product was abused or misused; including but not limited to Speaker product that has been improperly-powered (under or over powered), causing thermal (burnt voice coil) and/or mechanical failure (torn surrounds or spiders), damage caused by accident, mishandling, improper installation, negligence, normal wear and tear, excessive water or heat damage, freight damage or products that have been altered in any way. (The warranty is not transferable and will neither apply to products purchased from unauthorized dealers nor product owned by anyone other than the original purchaser from an authorized Wet Sounds dealer.) Wet Sounds is not responsible for any damages to a consumer's boat or person from a product failure. The warranty is void if Wet Sounds deems the product was installed or used improperly. Wet Sounds shall not be responsible for any incidental or consequential damages, except to the extent provided (or prohibited) by applicable law.

What Wet Sounds, Inc. Will Do

Wet Sounds, Inc will repair any part of your product that proves to be defective in materials or workmanship. In the event repair is not possible, Wet Sounds, Inc. will replace the product in question. If it is deemed necessary, Wet Sounds, Inc. will either replace the entire product with a refurbished unit or it will be replaced with a model that is similar in price if that model is no longer available. Labor cost and materials needed to complete this service will be at no charge to the purchaser. Additionally, the cost of shipping to the consumer is also covered under this warranty.

How to Obtain Warranty Service

Contact Wet Sounds, Inc. either by phone at 877-938-7757 or by email at warranty@wetsounds.com. A service representative will assist you in the necessary actions to verify that the problem that you are experiencing is covered under warranty. If it is in fact a warranty issue, Wet Sounds will issue an RA number for tracking purposes and give instructions on sending the product in for evaluation.

How State Law Applies

This warranty gives you specific legal rights, and you may also have other rights which vary from state to state.

Internet Warning

Wet Sounds, Inc. products sold on any unauthorized website or internet auction site are void of any and all manufacturer's warranty. Please contact Wet Sounds at 877-938-7757 or visit our website at www.wetsounds.com to search for an authorized site and/or an authorized retailer near you.

Caution & Respect

Wet Sounds speakers can achieve very high sound pressure levels. Please use this product responsibly. Be aware that sound travels great distances across water so please respect other boaters especially while loading/unloading at the ramp or dock. Wet Sounds, Inc. is not responsible for any violations of the law that may be a direct result of excessive volume. Please abide by the rules but have fun doing it.

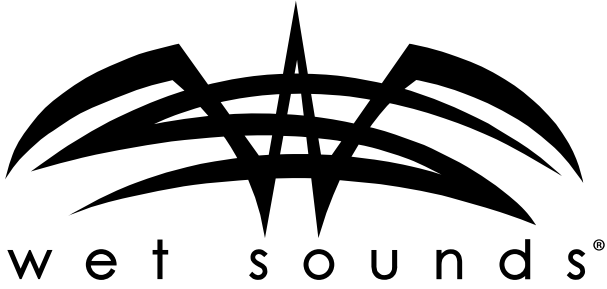

Wet Sounds, Inc.
www.wetsounds.com
877-938-7757

2975 Louise Street
Rosenberg, Texas 77471 USA

© 2022 Wet Sounds, Inc. All Rights Reserved. WET SOUNDS and associated logos where applicable are registered trademarks of Wet Sounds Corporation in the United States and/or other countries. All other trademarks are the property of their respective owners.

ZERO SERIES